







--	--	--	--



CONFIDENTIAL



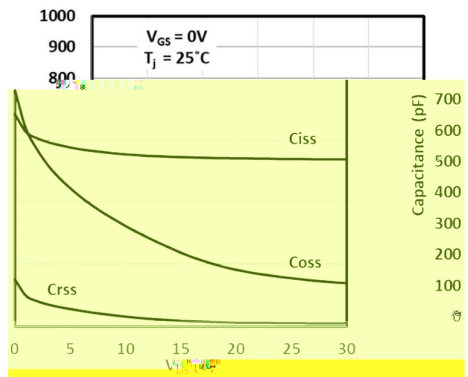
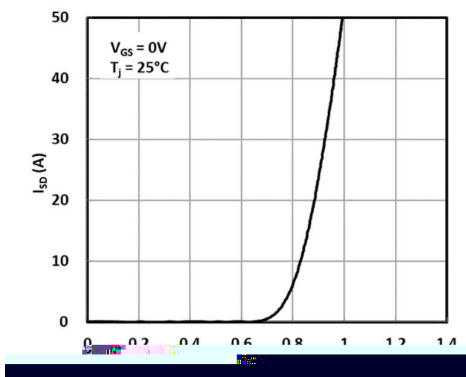
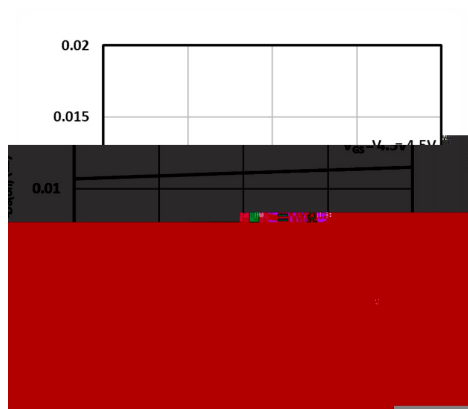
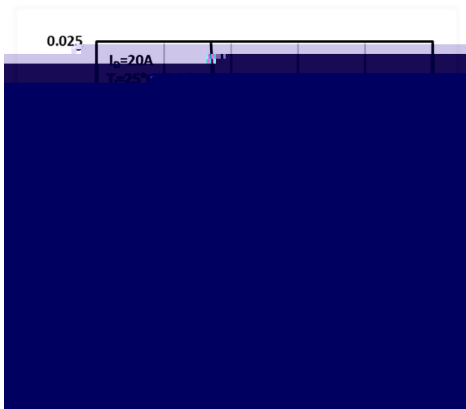
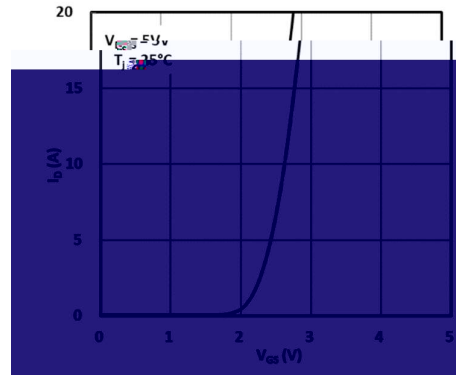
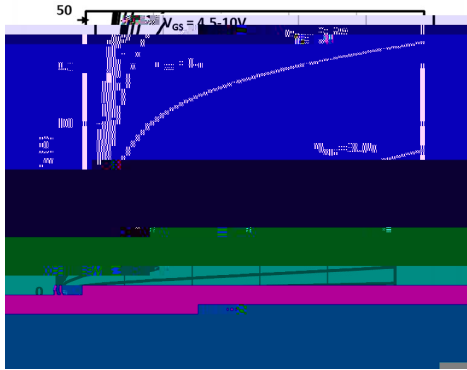

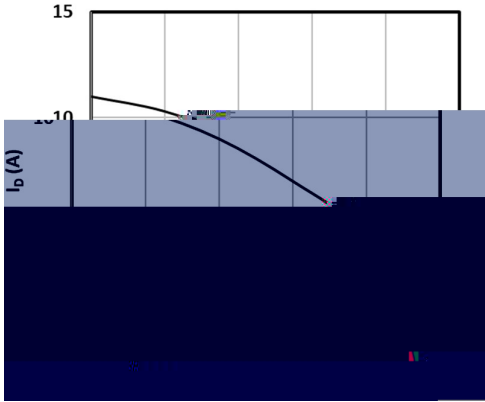
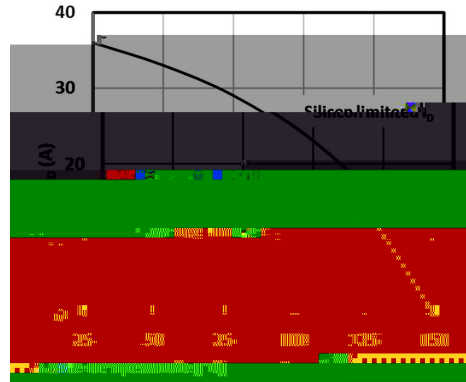
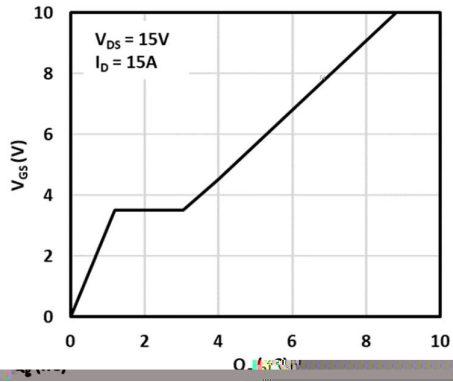



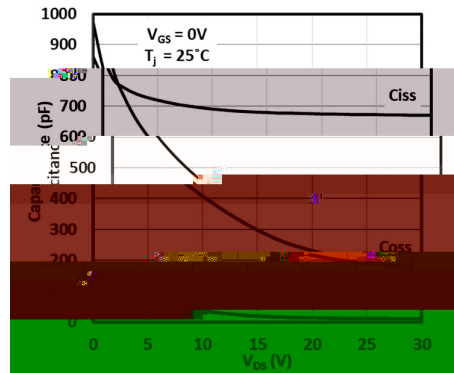
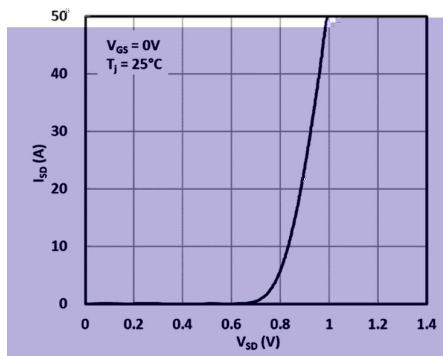
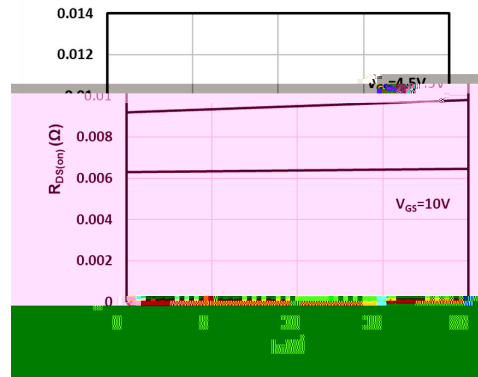
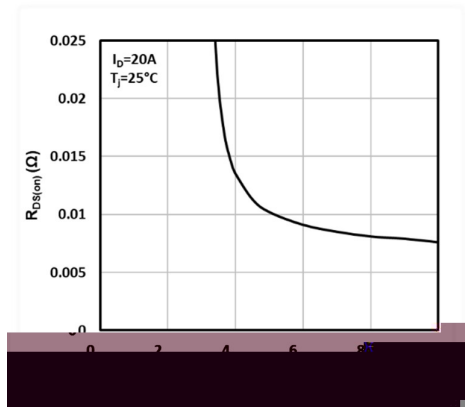
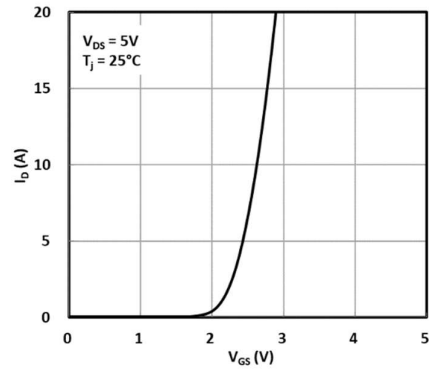
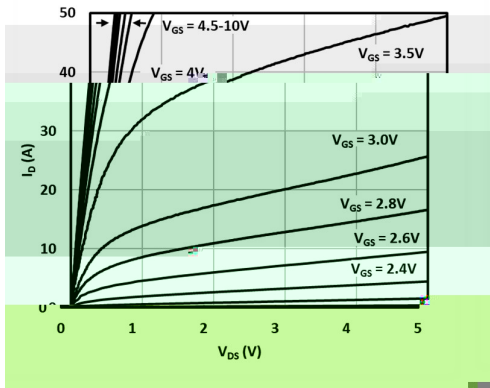



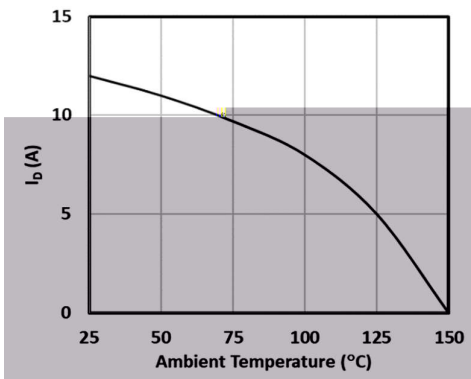
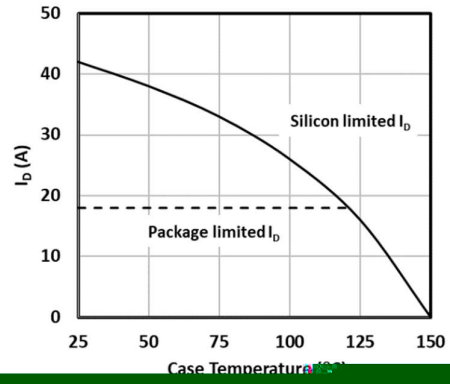
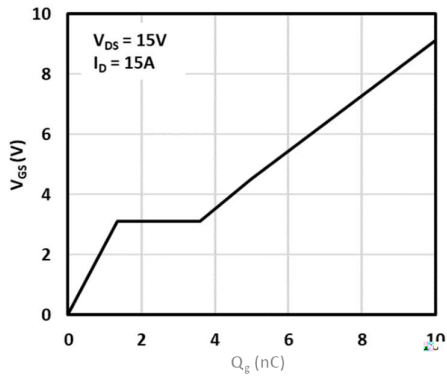

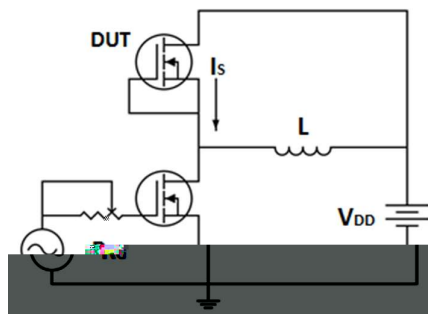
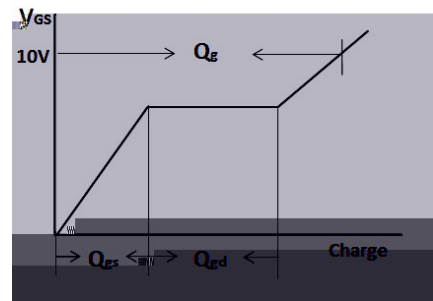
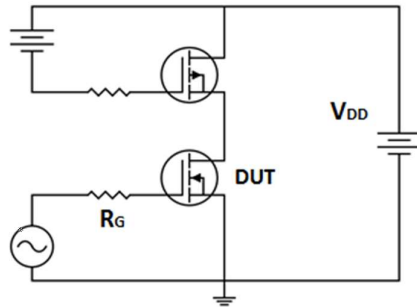
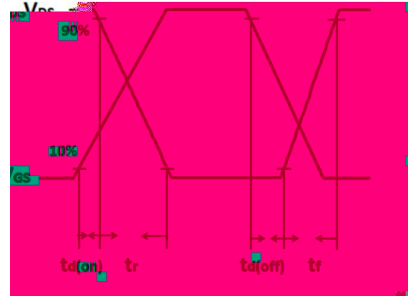
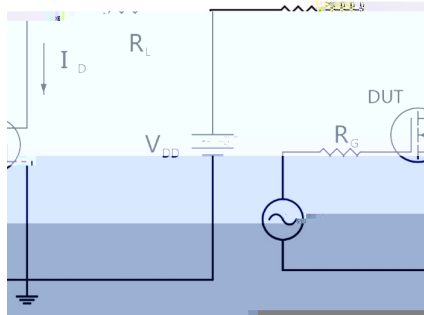

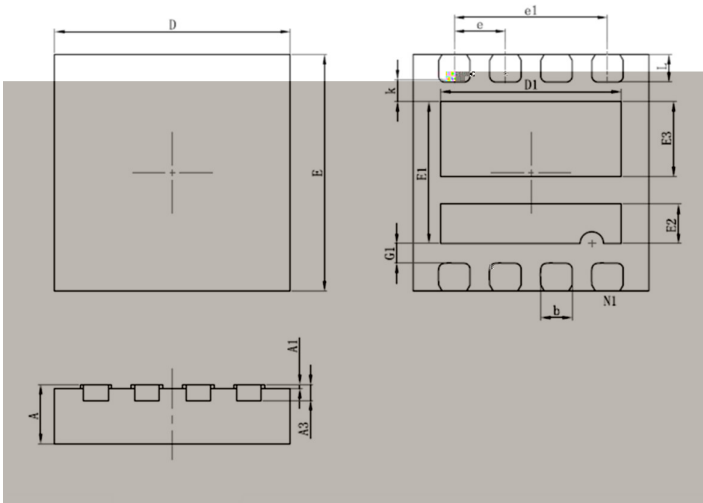
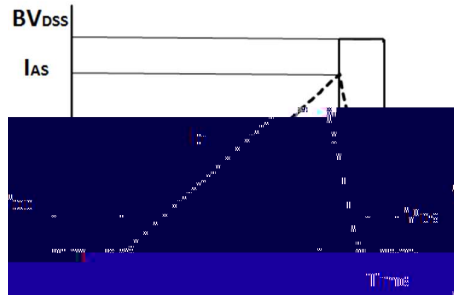
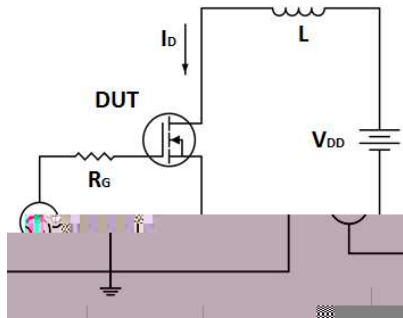
Symbol	Dimensions In Millimeters	
	Min.	Max.
A	0.700	0.800
A1	0.000	0.050
A3	0.203REF.	
D	2.950	3.050
E	2.950	3.050
D1	2.250	2.350
E1	1.700	1.900
E2	0.450	0.550
E3	0.900	1.000
k	0.200	0.300
G1	0.200	0.300
b	0.350	0.450
e	0.650BSC	
e1	1.95BSC	
l	0.300	0.400



-

-

-

-

-

-

-

-

-